

# Tindle Construction

General Contracting

Ronnie Tindle | Estimator

O: 251-675-6117

C: 251-463-2804

E: rtindle@tindleconstruction.net

210 Saraland Blvd S, Saraland, AL 36571

AL GC# 51512 | MS GC# 4343-SC

Donald W. (Buck) Tindle: Owner

Date: March 3, 2025

ATTN: Wanda Gautney

Project: Baldwin County Courthouse Cort Room 1  
312 Courthouse Square, Bay Minette, AL. 36507

Tindle Construction, LLC is pleased to submit an estimate of **\$45,630.00** to furnish the necessary labor, materials, tools, equipment and supervision to:

1. Demo:
  - a. Existing 11' pony wall with gate. (Reinstall Gate on new wall)
  - b. Existing clerks desk.
2. Install:
  - a. 20' of pony wall with heavy gauge metal studs and casework to match casework on existing walls.
  - b. 5' of 7'2" tall wall with heavy gauge metal studs, drywall and casework to match casework on existing walls.
  - c. Paint any new exposed or existing drywall affected by construction. Match existing color corner to corner.
  - d. Install new black floor transition strip at removed pony wall.
  - e. New custom-built laminate desk to increase size to 6'6" long.
  - f. New expandable security gate to separate clerks' area from copy machine and new 7'2" wall.
  - g. (1) 19'9" X 6' Tall and (2) 11'3" X 6' Tall Straight Wall Telescoping Portable Partition Walls (Black Fabric Quoted)
3. Electrical:
  - a. Remove and reinstall electrical and data in desk.

**Clarifications:**

1. Based on Monday - Friday 7:00-3:30 work schedule.
2. Laminate color to be matched as closely as possible and approved before ordering.
3. Shop drawings to be approved by owner before construction.
4. Submittals to be approved by owner before ordering.

**Exclusions:**

1. Permit
2. Bonding

Ronnie W. Tindle  
Estimator  
Tindle Construction LLC.

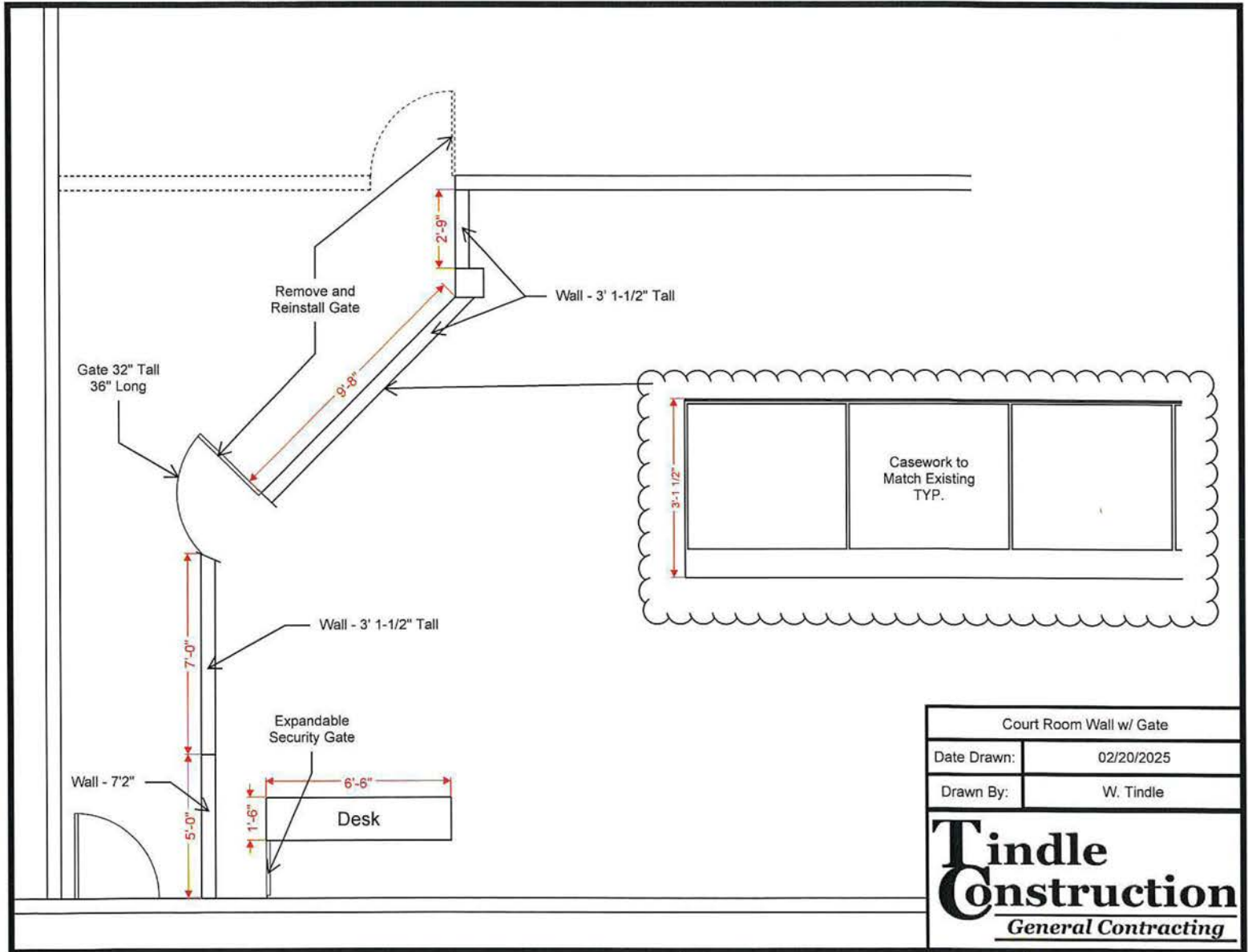

Court Room Wall w/ Gate	
Date Drawn:	02/20/2025
Drawn By:	W. Tindle

**Tindle**  
**Construction**  
 General Contracting

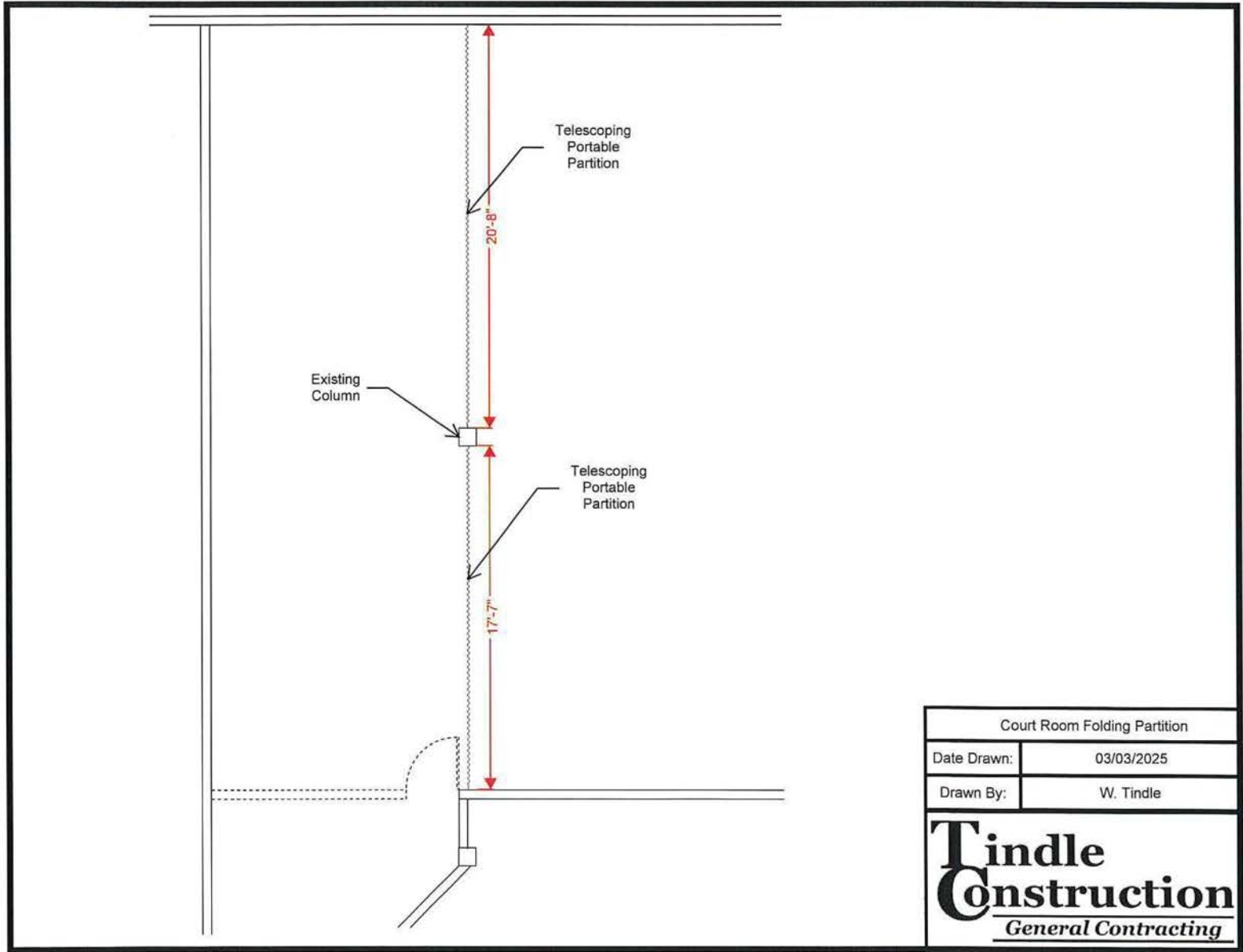

Court Room Folding Partition	
Date Drawn:	03/03/2025
Drawn By:	W. Tindle

**Tindle**  
**Construction**  
*General Contracting*



VEVOR Single Folding Security Gate, 48" H x 66" W Folding Door Gate, Steel Accordion Security Gate, Flexible Expanding ...

Size: 66 x 48 inch

Description

Specification

Questions and Answers

Reviews

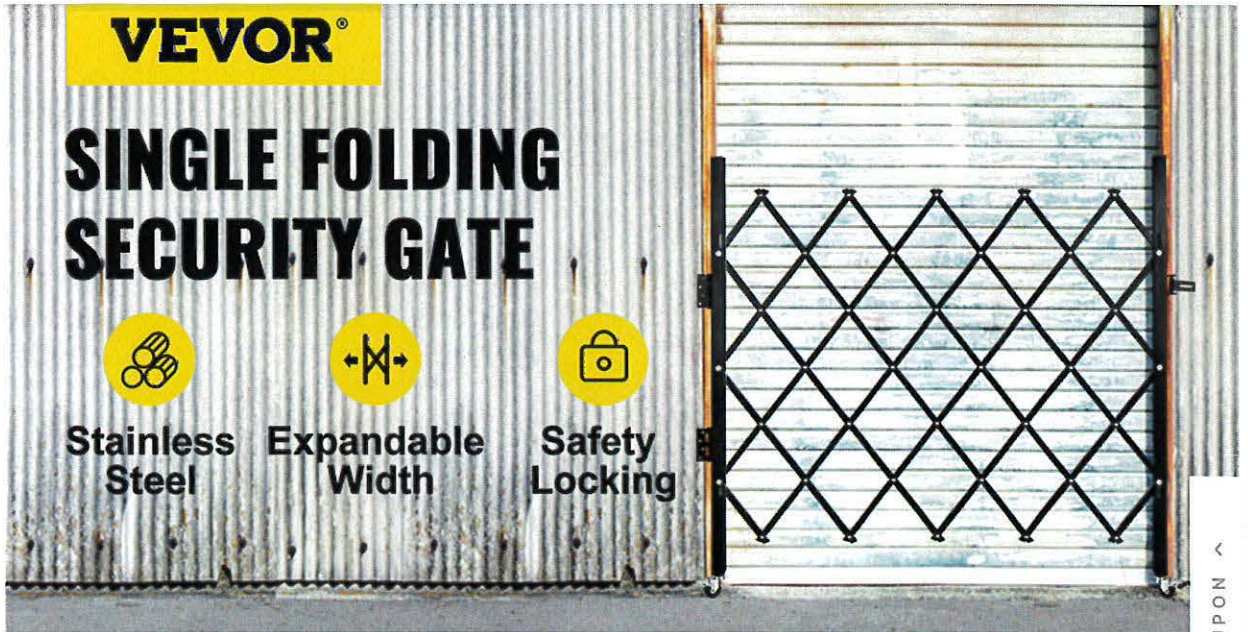

GET COUPON <



### Single Folding Security Gate

*Adjustable Width & Strong Construction & Good Mobility*

Our folding security gates are made of strong 3/4" G14 channel steel, with a black powder coat finish to preserves the integrity and extend its longevity. The safety lock design increases the security, and an installation kit can ease your assembly. Such stretchable door gates are the ideal gates for securing your high-traffic hallways or entryways in any business or industry.

- Single Folding Door
- Durable Security Gate
- Flexible Rolling Caster
- Easy Lock & Installation

VEVOR is a leading brand that specialize Along with thousands of motivated empl dedicated to providing our customers wi tools at incredibly low prices. Today, VEV markets of more than 200 countries with 10 milli members.

#### Why Choose VEVOR?

- Premium Tough Quality
- Incredibly Low Prices
- Fast & Secure Delivery
- 30-Day Free Returns
- 24/7 Attentive Service

Live Chat

Contact Us

Top

©2024 VEVOR. All rights reserved. VEVOR is a leading brand that specialize in providing high-quality products at low prices. VEVOR is committed to providing our customers with the best shopping experience.



VEVOR Single Folding Security Gate, 48" H x 66" W Folding Door Gate, Steel Accordion Security Gate, Flexible Expanding ...  
Size: 66 x 48 inch

Description Specification Questions and Answers Reviews

# EXPANDABLE WIDTH 5.6 FEET

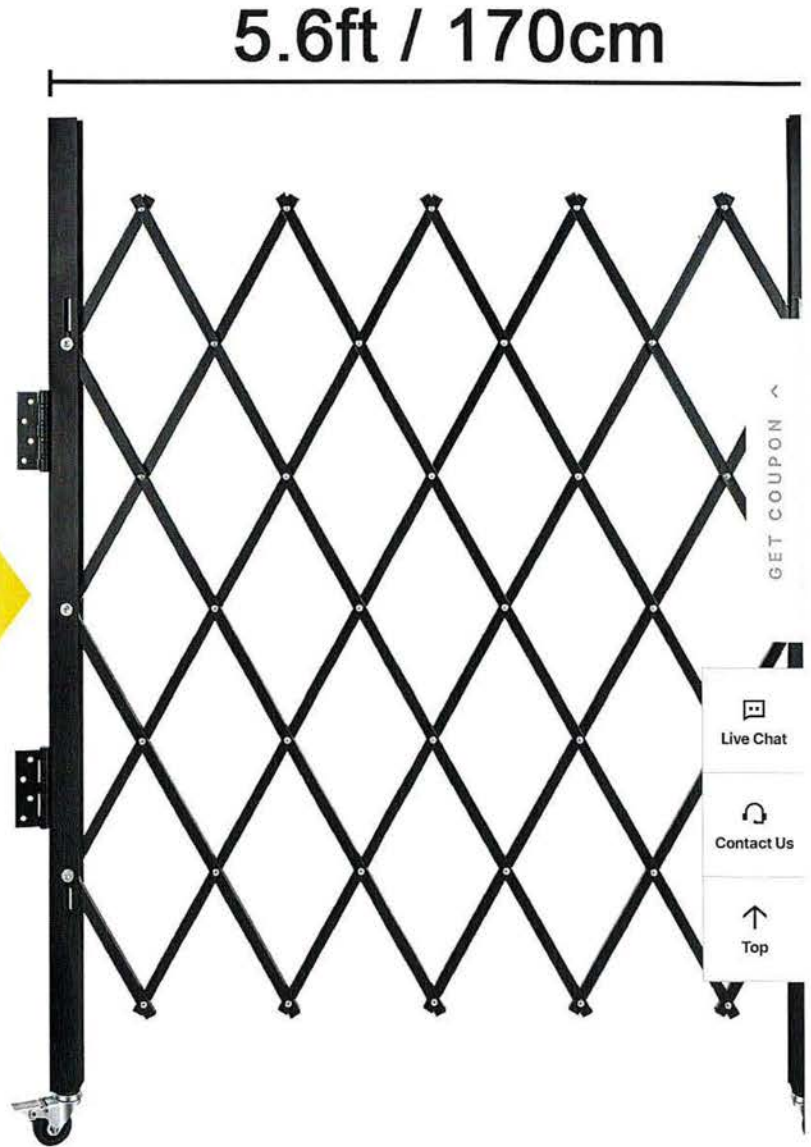
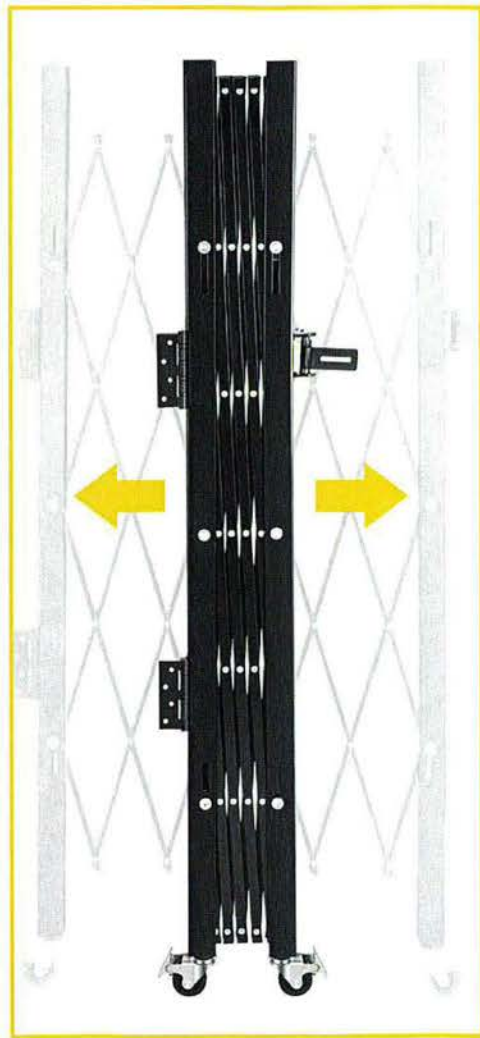

### Expandable Width 5-1/2 Feet

The width of our single folding gate can expand from 6.3" to 66". Height: 48". It offers physical protection for your assets, belongings, or goods, giving your property a professional look.



VEVOR Single Folding Security Gate, 48" H x 66" W Folding Door Gate, Steel Accordion Security Gate, Flexible Expanding ...  
Size: 66 x 48 inch

Description Specification Questions and Answers Reviews

# DURDY G14 CHANNEL STEEL



GET COUPON

Live Chat

Contact Us

↑ Top



Rust-proof



Long Term Use



Weather-proof



Power Coating

### DURDY G14 Channel Steel

The metal fence security gate is constructed of 3/4" 14 gauge channel steel, durable for long-lasting use. Its black powder-coated finish prevents rust, and zinc-plated rivets resist corrosion.



VEVOR Single Folding Security Gate, 48" H x 66" W Folding Door Gate, Steel Accordion Security Gate, Flexible Expanding ...

Size: 66" x 48 inch

Description

Specification

Questions and Answers

Reviews



### 360° Rolling Wheel

The rolling wheels on the bottom of the expanding security gate have max flexibility to swing up to 360 degrees for a clear-opening/ closed state, while with its brake to instant fix the position.



VEVOR Single Folding Security Gate, 48" H x 66" W Folding Door Gate, Steel Accordion Security Gate, Flexible Expanding ...

Size: 66 x 48 inch

Description

Specification

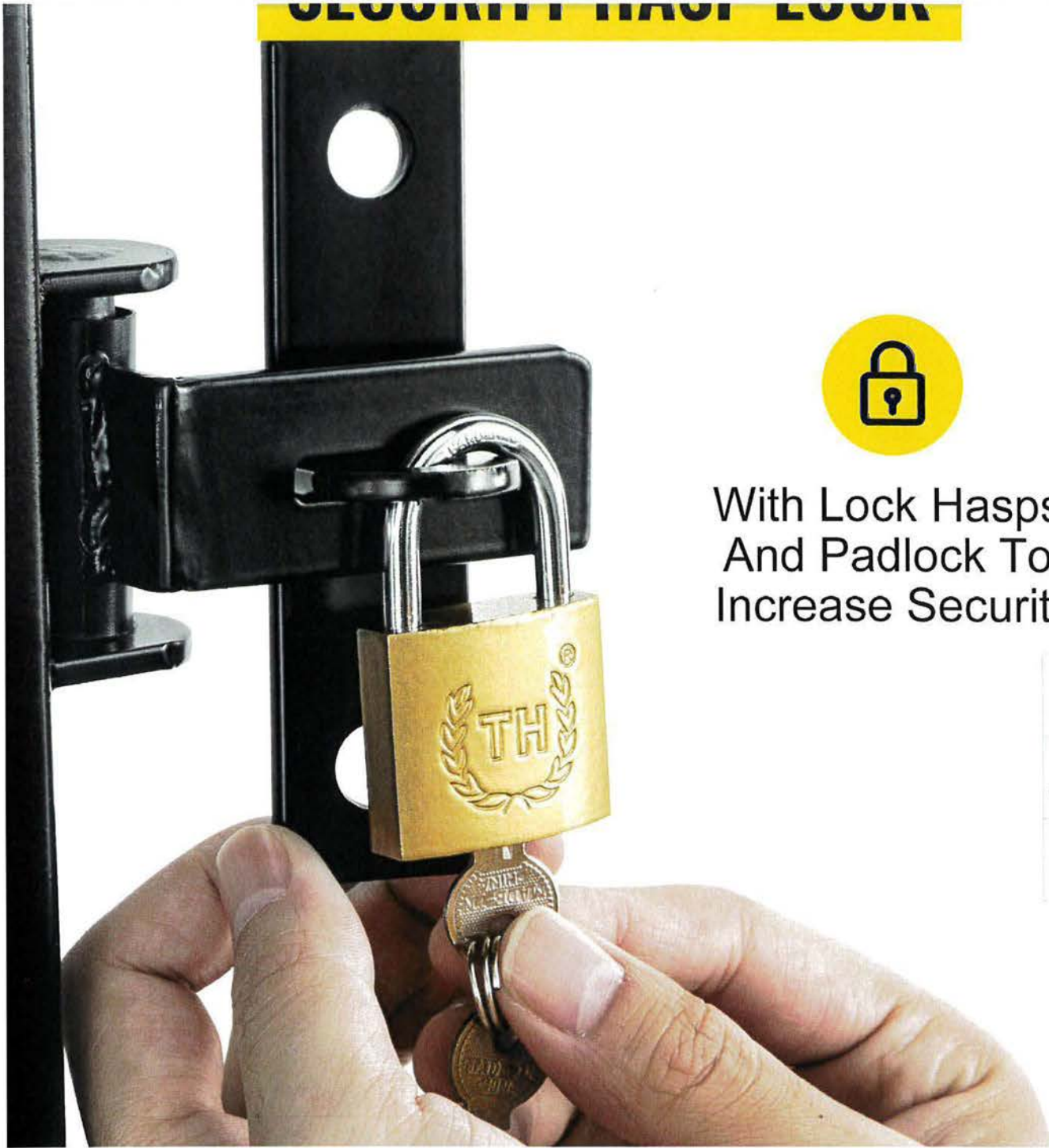

Questions and Answers

Reviews



With Lock Hasps  
And Padlock To  
Increase Security

GET COUPON ^

-  Live Chat
-  Contact Us
-  Top

**Security Lock Design**

Our barricade gate comes with specially designed lock hasps to match the secure padlock. And with three keys enclosed to the padlock for in case, you can use it in the entrance without ar





VEVOR Single Folding Security Gate, 48" H x 66" W Folding Door Gate, Steel Accordion Security Gate, Flexible Expanding ...

Size: 66 x 48 inch

Description

Specification

Questions and Answers

Reviews

# EASY INSTALLATION

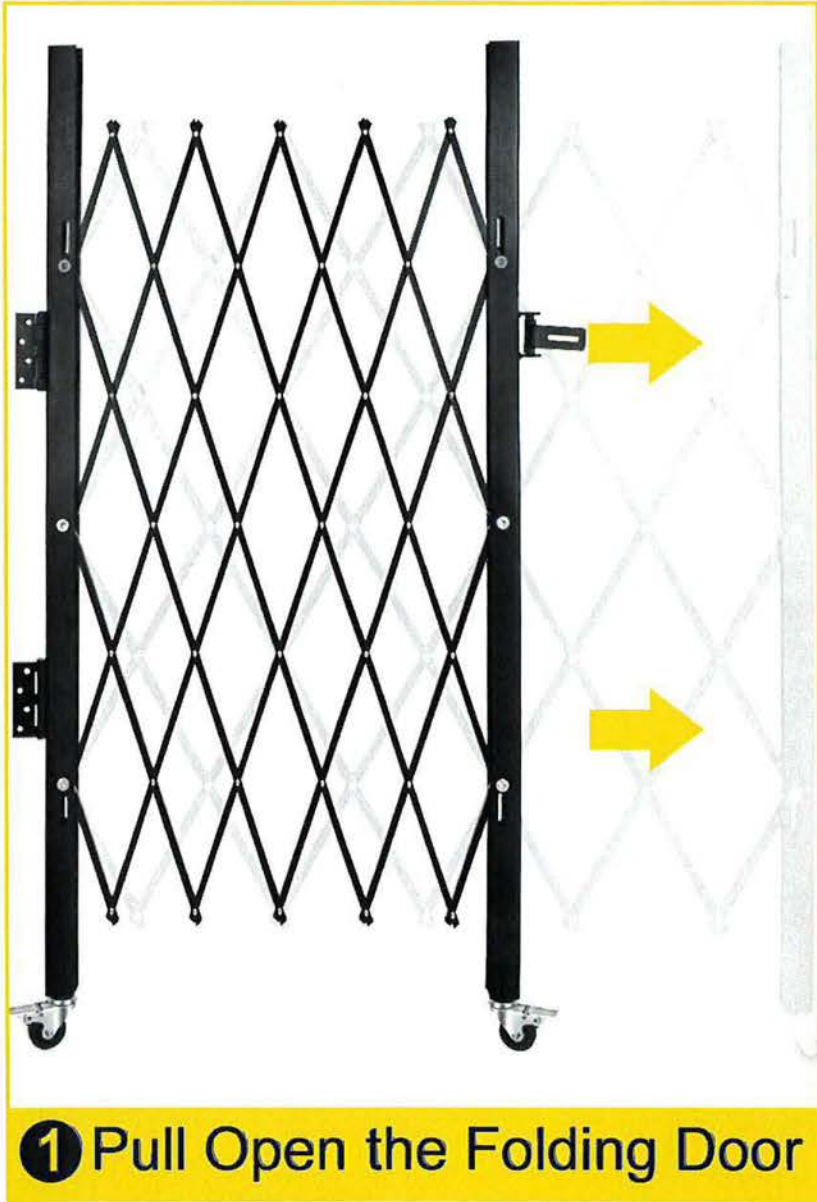

### Easy Installation

Accordion gates can be either recess or surface mounted and are equipped with mounting hardware for easy installations. Just drill some holes and mount correctly on the cement or brick



VEVOR Single Folding Security Gate, 48" H x 66" W Folding Door Gate, Steel Accordion Security Gate, Flexible Expanding ...

Size: 66" x 48 inch

Description

Specification

Questions and Answers

Reviews

# EXTENSIVE APPLICATION



Factory



Shop



GET COUPON <



Garage



Garden

-  Live Chat
-  Contact Us
-  Top

## Extensive Application

These accordion doorway gates can control access to hallways and receiving doors without affecting ventilation or visibility. Widely used for door securities of the basement, garage, storefr



**VEVOR Single Folding Security Gate, 48" H x 66" W Folding Door Gate, Steel Accordion Security Gate, Flexible Expanding ...**

Size: 66 x 48 inch

**Description**

**Specification**

**Questions and Answers**

**Reviews**

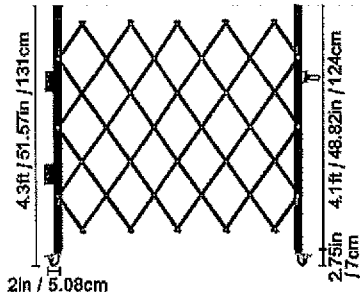

Door Type: Single Folding Door  
Collapsed Size: 4'H x 0.5'W / 48"H x 6.3"W  
Expanded Size: 4'H x 5-1/2' W / 48"H x 66"W  
Item Weight: 19.8 lbs/ 9 kg  
Color: Black



**Package Content**

- 1x Folding Security Gate
- 1x Padlock with Keys
- 1x Set of Mounting Tool

GET COUPON <

 **Live Chat**

 **Contact Us**

 **Top**



**VERSARE**

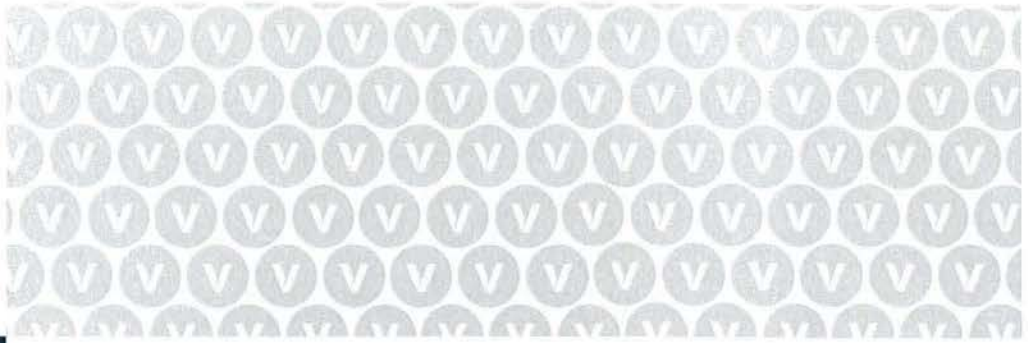

**STRAIGHTWALL  
SLIDING PORTABLE  
PARTITION**

Available in Fabric, Polycarbonate,  
SoundSorb & Laminate



Wall-Mounted Option  
Available



Exclusive telescoping hinge option keeps all panels in a straight line regardless of length



Increase stability and eliminate tripping hazards with full-sized end panels



Locking casters on each end panel can be quickly activated for stationary use



Lightweight aircraft aluminum frames are strong, durable and safer than steel dividers



SoundSorb options provides enhanced sound dampening and acoustics control



Custom printing available to advertise your event or business



Versare Solutions, LLC  
3236 California St. NE  
Minneapolis, MN 55418



[www.versare.com](http://www.versare.com)



855-647-6909



800-310-4874

## Heights

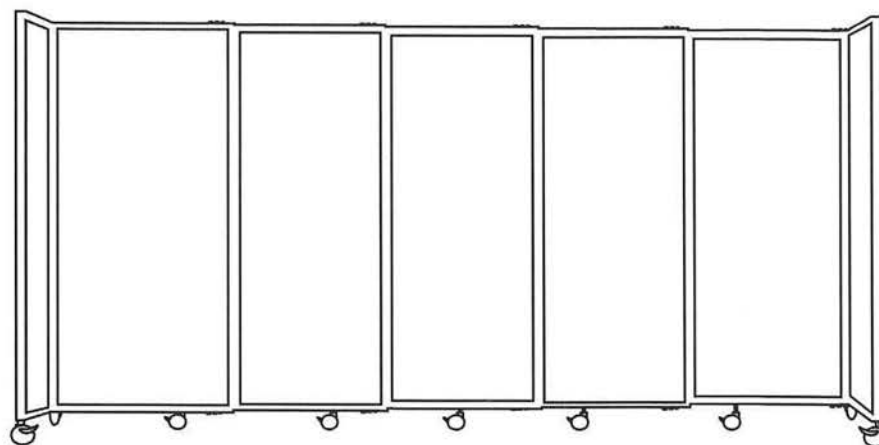
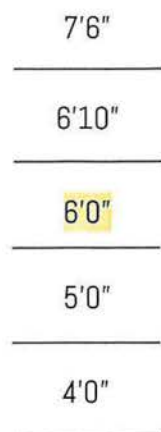

\* Wall-Mounted version

## SPACE-SAVING...SIMPLIFIED.

Everyone appreciates a straight shooter. Maybe that's the reason the StraightWall is one of our most popular partitions. Featuring unique, telescoping hinges, this room divider maintains a perfectly straight line regardless of length. The smooth, sturdy hinge movement provides an ease of use not found on any other partition. The StraightWall's lightweight, aircraft aluminum frame stands apart from heavy, wobbly steel dividers found elsewhere on the market. Low-profile casters and full-sized end panels provide superior stability and safety than spring-loaded wheels and awkward railings found on rivals' partitions. We take pride in our engineering and are confident we offer a superior build quality at a lower price. Customize the StraightWall to seamlessly integrate with your environment! Choose from over 20 unique colors in pushpin-accepting fabric or try our SoundSorb recycled, felted acoustical material to dampen sound and control acoustics. Want a really unique look that can be quickly spray-cleaned? Our polycarbonate plastic panels are available in several colors and translucencies, while our woodgrain laminate options will add a touch of class to any location.



COLLAPSED

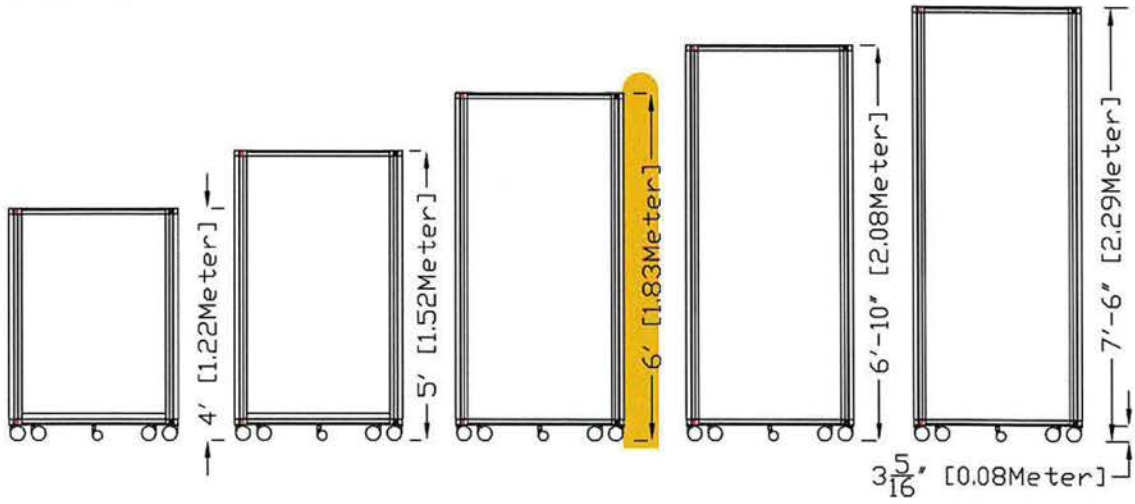

3 Panel Folds to (6.9 SQFT) 5 Panel Folds to (7.4 SQFT) 7 Panel Folds to (7.9 SQFT) 9 Panel Folds to (8.4 SQFT)

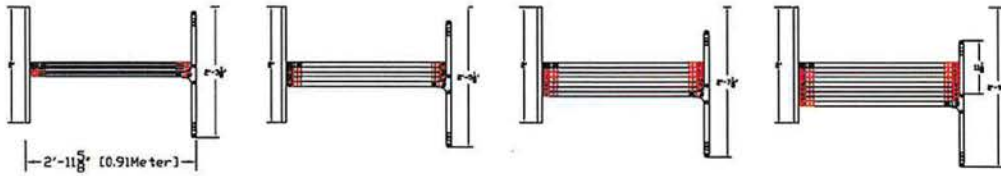

EXPANDED

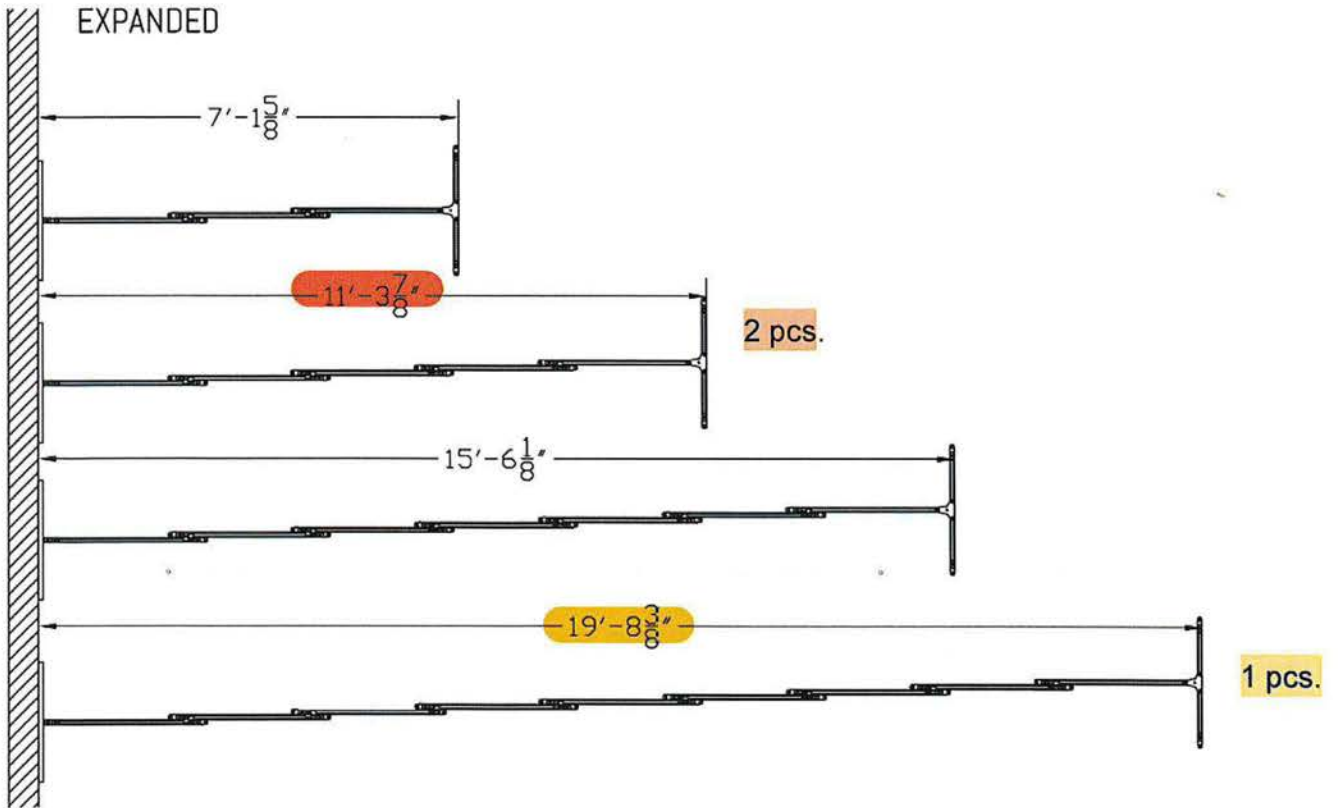

# FABRIC CHART

Palette • Coastal  
Strata • Metro



# VERSARE



855.647.6909



800.310.4874



www.versare.com

## Fabric Color Options



ROYAL BLUE



NAVY BLUE



CARIBBEAN



SAND



RED



PURPLE



BLACK



SLATE



CHARCOAL GRAY



CLOUD GRAY



MOCHA

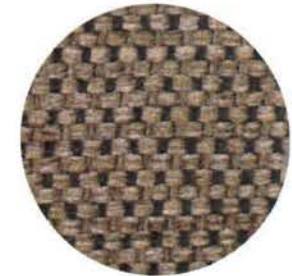

LATTE



WARM PEBBLE



POWDER BLUE

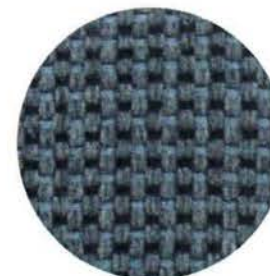

OCEAN

### Maintenance:

Panels may be cleaned with mild, water-free solvents or water-based cleaning agents or foam.

### Flammability:

BS 476/7 Class 1  
DIN 4102 B-1 (10&16 mm) NSP 92501 M-1, M-2

ASTM D-635 CC-1

ASTM-E-84 Class A EN  
13501 B, s1, d0